

99157

Dimensions

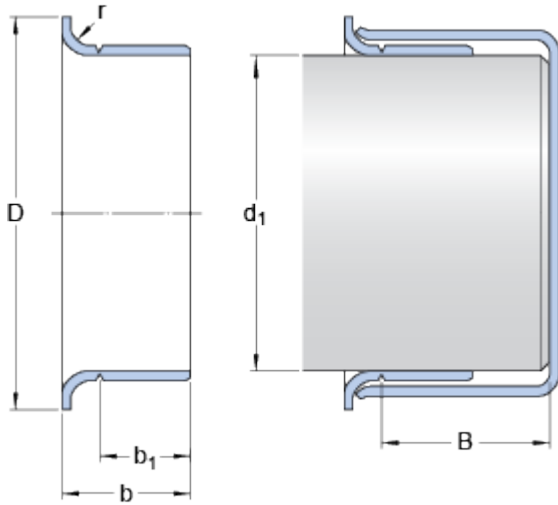

Nominal dimensions

d_1		40	mm
D		46.99	mm
Tolerance outside diameter D	\pm	1.6	mm
b		16.002	mm
Tolerance width b	\pm	0.8	mm
b_1		13.005	mm
Tolerance width b_1	\pm	0.8	mm
B	max.	25.984	mm
r	max.	3.18	mm

Shaft diameter range

d_1	min.	39.929	mm
d_1	max.	40.081	mm